

# COUNTER/TIMER CT SERIES

M A N U A L



Thank you very much for selecting Autonics products.  
For your safety, please read the following before using.

## Caution for your safety

- ※ Please keep these instructions and review them before using this unit.
- ※ Please observe the cautions that follow:
- Warning** Serious injury may result if instructions are not followed.
- Caution** Product may be damaged, or injury may result if instructions are not followed.
- ※ The following is an explanation of the symbols used in the operation manual.
- ⚠ caution: Injury or danger may occur under special conditions.

## Warning

- In case of using this unit with machineries (Nuclear power control, medical equipment, vehicle, train, airplane, combustion apparatus, entertainment or safety device etc), it requires installing fail-safe device, or contact us for information required.**  
It may result in fatal damage, fire or human injury
- This unit must be mounted on Panel.**  
It may give an electric shock.
- Do not connect terminals when it is power on.**  
It may give an electric shock.
- Do not disassemble and modify this unit, when it requires. If needs, please contact us.**  
It may give an electric shock and cause a fire.

## Caution

- This unit shall not be used outdoors.**  
It might shorten the life cycle of the product or give an electric shock.
- When wire connection, No.20AWG(0.50mm<sup>2</sup>) should be used and screw bolt on terminal block with 0.74N · m to 0.90N · m strength.**  
It may result in malfunction or fire due to contact failure.
- Please observe specification rating.**  
It might shorten the life cycle of the product and cause a fire.
- Do not use the load beyond rated switching capacity of Relay contact.**  
It may cause insulation failure, contact melt, contact failure, relay broken, fire etc.
- In cleaning the unit, do not use water or an organic solvents.**  
It might cause an electric shock or fire that will result in damage to the product.
- Do not use this unit at place where there are flammable or explosive gas, humidity, direct ray of the sun, radiant heat, vibration, impact etc.**  
It may cause explosion.
- Do not inflow dust or wire dregs into inside of this unit.**  
It may cause a fire or mechanical trouble.

## Ordering information

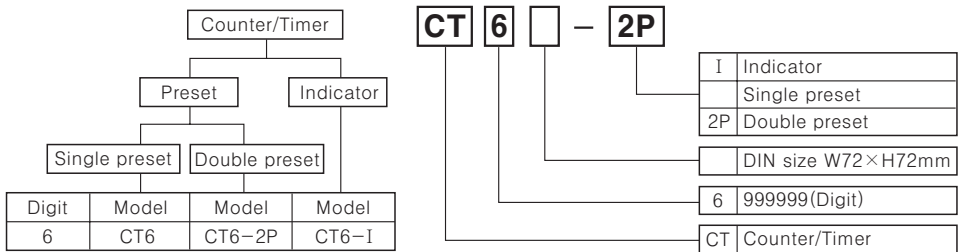

※ When use CT6-2P as Timer, unable to use it as double preset.  
※ The above specification are changeable without notice anytime.

## Specifications

Series	CT		
Digit	6		
Model	Single preset	CT6	
	Double preset	CT6-2P	
	Indicator	CT6-I	
Power supply	AC power	100-240VAC 50/60Hz	
	DC power	24-60VDC	
Allowable voltage range	90 to 110% of rated voltage (AC power type)		
Power consumption	AC power	Indicator: Approx. 9VA, Single preset & Double preset: Approx. 10VA	
	DC power	Indicator & Single preset: Approx. 5W, Double preset: Approx. 6W	
CPS of INA, INB	Selectable 1cps, 30cps, 1kcps, 5kcps, 10kcps		
Min. input signal width	Counter	Reset input: Selectable 1ms or 20ms	
	Timer	INA, INHIBIT, RESET, BATCH RESET (except CT6-I): Selectable 1ms or 20ms	
Input	Selectable voltage input or No-voltage input		
	[Voltage input] Input impedance is 5.4kΩ, "H" level: 5-30VDC, "L" level: 0-2VDC [No-voltage input] Short-circuit impedance: Max. 1kΩ, Residual voltage: Max. 2VDC, Open-circuit impedance: Min. 100kΩ		
One-shot output	Counter	10 / 50 / 100 / 200 / 500 / 1000 / 2000 / 5000ms	
	Timer	10 / 50 / 100 / 200 / 500 / 1000ms	
Control output	Contact	Type	Single preset type: SPDT(1c), Double preset type: SPST(1a) for first output, SPDT(1c) for second output
		Capacity	NO: 250VAC 3A resistive load, NC: 250VAC 2A resistive load
	Solid-state	Type	Single preset type: 2 NPN open collector (OUT, BATCH) Double preset type: 3 NPN open collector (OUT1, OUT2, BATCH) Solid state output is consist of photo-coupler and insulated with inner circuit
Capacity	Max. 30VDC, Max. 100mA		
Memory retention	10 years		
External sensor power	12VDC ±10%, 100mA Max.		
Ambient temperature	-10 to 55°C (at non-freezing status)		
Storage temperature	-25 to 65°C (at non-freezing status)		
Ambient humidity	35 to 85%RH		
Timer	Repeat error	Power ON start: ±0.01% ±0.05sec	
	Set error	Signal start: ±0.01% ±0.03sec	
	Voltage error		
	Temperature error		
Insulation resistance	Min. 100MΩ (at 500VDC)		
Dielectric strength	2000VAC 50/60Hz for 1 minute		
Noise strength (AC power)	±2kV the square wave noise (pulse width: 1μs) by the noise simulator		
Vibration	Mechanical	0.75mm amplitude at frequency of 10 to 55Hz in each of X, Y, Z directions for 1 hour	
	Malfunction	0.5mm amplitude at frequency of 10 to 55Hz in each of X, Y, Z directions for 10 minutes	
Shock	Mechanical	300m/s <sup>2</sup> (Approx. 30G) 3 times at X, Y, Z direction	
	Malfunction	100m/s <sup>2</sup> (Approx. 10G) 3 times at X, Y, Z direction	
Relay life cycle	Mechanical	Min. 10,000,000 times	
	Electrical	Min. 100,000 times (NO: 250VAC 3A resistive load, NC: 250VAC 2A resistive load)	
Protection	IP65 (Front panel only)		
Weight	AC power	CT6: Approx. 264g	CT6-2P: Approx. 271g
	DC power	CT6: Approx. 263g	CT6-2P: Approx. 270g

## Front panel identification

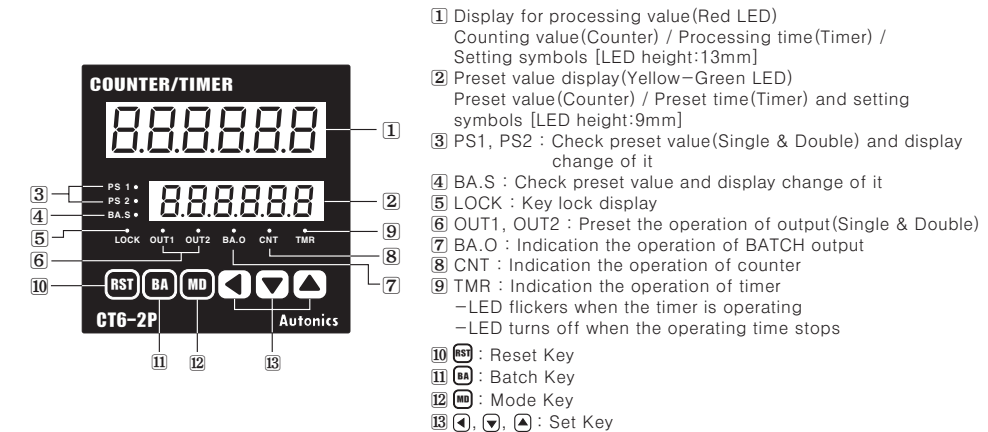

※ PS2 will be changed to PS and OUT2 to OUT, there is no PS1, OUT1 LED in CT6.  
※ There is no PS1, PS2, BA.S, OUT1, OUT2, BA.O LED in CT6-I.  
※ There is no MD key in CT6-I.

## Dimensions

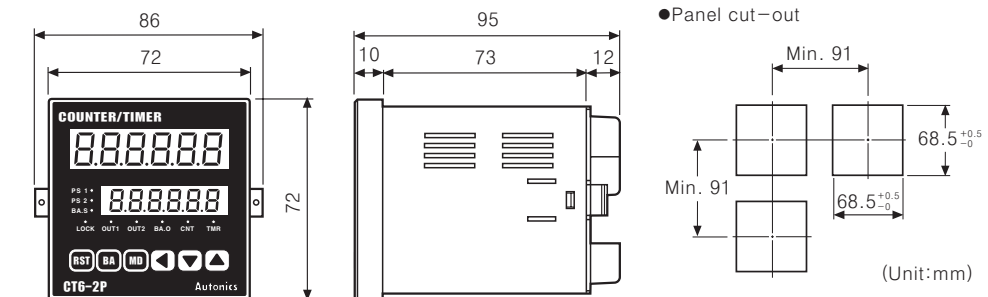

## Connections

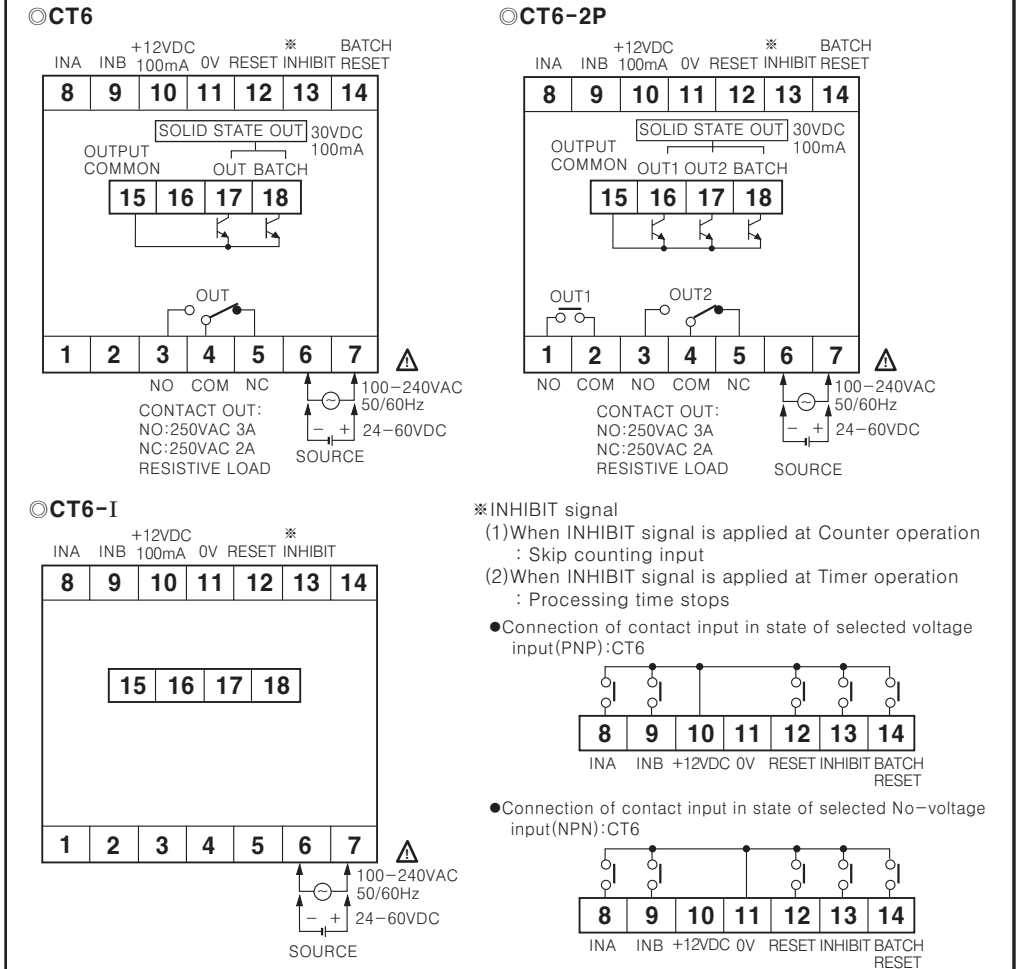

## Input connection

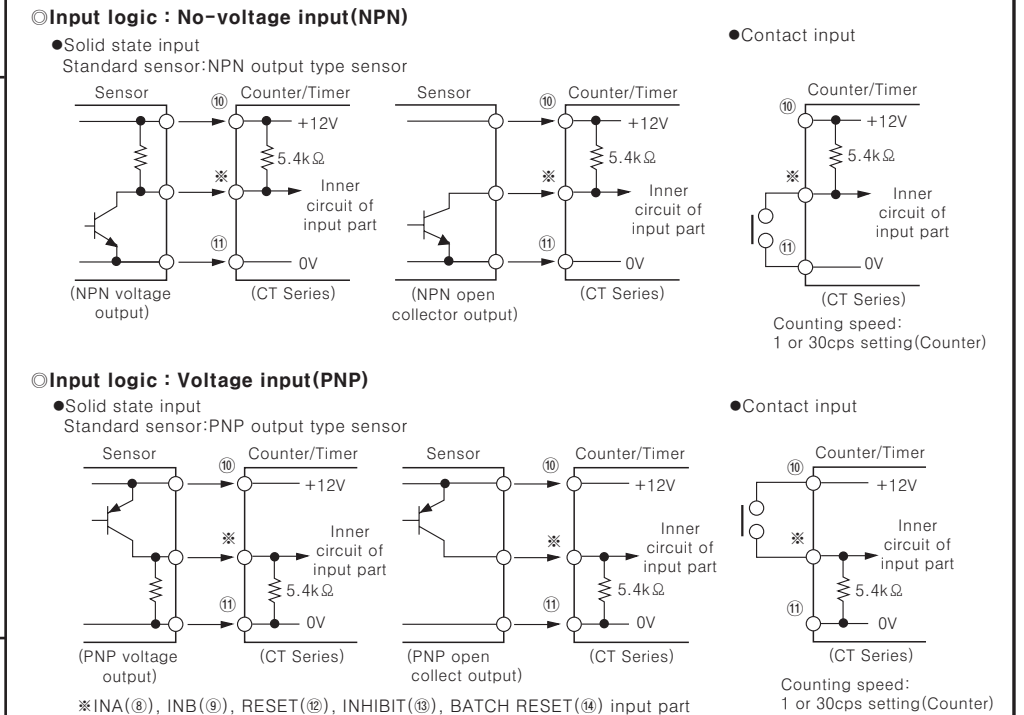

## Output connection

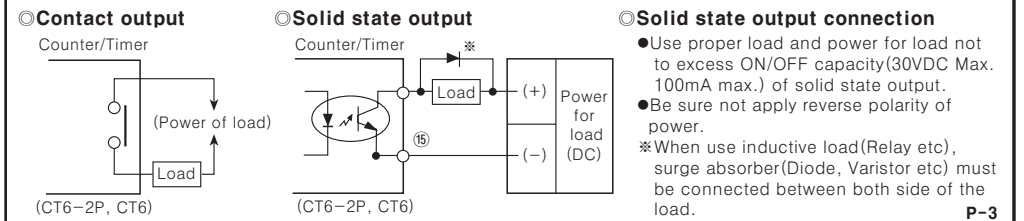

## Input logic selection

It is easy to change input logic by S/W for input logic conversion.

### Select PNP(Voltage input)

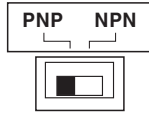

### Select NPN(No-Voltage input)

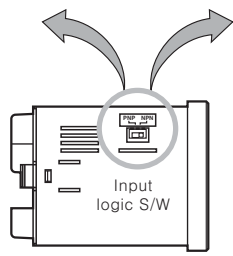
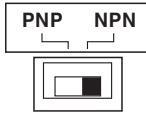

## Change of preset value in Counter operation

### Change the preset value in the single preset type(CT6)

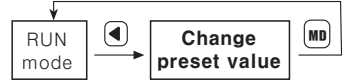

※If the input signal in while changing preset value, it controls the output and the counting function. In state of changing preset value, if no key is touched for 60 sec., the counter will return to RUN mode. After change the preset value as "0", there is **RST** Key input or RESET input at RUN mode, the output will be maintained as OFF. (But in state of the output mode is "T", if change single preset value as "0", the single output will be maintained as ON.)

### Change the preset value in the double preset type(CT6-2P)



### How to change in the single preset type: To change the preset value from 175 to 180

- Press **←** key to enter in state of changing preset value, the prior preset value is indicated and the first digit "5" flashes.
- Change "5" to "0" by pressing **↓** key 5 times, and shift the flickering ("7" is flickering digit) to the second digit by pressing **←** key once.
- Change "7" to "8" by pressing **↑** key once.
- It will be completed to preset value and return to RUN mode by pressing **MD** key.

\*Whenever **←** key is pressed in the state of changing preset value, the flickering digit shifts from the right to the left.

## Change of preset value in Timer operation

### To change preset time in case of the output is not FLK

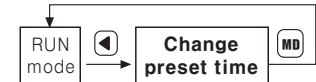

### To change preset time in case of the output is FLK



※In state of changing preset value, if no key is touched for 60sec., the timer will return to RUN mode.

### To change the t.oFF time from 30sec. to 50sec. and the t.on time from 40sec. to 20sec. (Output mode : FLK, Time range : 0.1s~9999.9s)

- Pressing **←** key to enter the state of changing preset time. The right first digit flickers. Shift the flickering digit to "3" position by pressing **←** key twice.
- Change "3" to "5" by pressing **↑** key twice. Set "t.oFF" time as pressing **MD** key which enters "t.on" mode automatically. The first digit flickering.
- Shift the flashing digit to "4" position by pressing **←** key twice.
- Change "4" to "2" by pressing **↓** key twice. It will be completed to preset value and return to RUN mode by pressing **MD** key.

\*Whenever **←** key is pressed in the changing mode of the preset time, the flickering digit shifts from the right to the left.

※When use CT6-2P as Timer, unable to use it as double preset.

## Batch count and Batch preset value(CT6, CT6-2P)

### Operation of Batch count

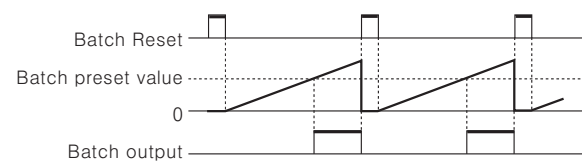

### Counting operation

Batch counting value is increasing until BATCH RESET signal applied. Batch counting value will be circulated when it is over 999999. Batch counting value is not affected by **RST** key input in front and external reset signal.

1) Batch counting operation in Counter operation  
When the value calculated from times of reaching to preset value is equal to Batch preset value, the batch output will be ON.  
When the control output of Batch is used, the time interval of count-up shall be over 10ms.

2) Batch counting operation in Timer operation  
When the value calculated from times of reaching to preset value is equal to Batch preset value, the batch output will be ON.  
In case of FLK output mode, counting value of Batch counter is increasing when Toff and Ton set time passed.

### Output operation of Batch counter

If the Batch output is ON, it will remain ON state until Batch reset signal is applied. When the power is cut off then supplied again in state of batch output is ON, Batch output keeps ON state until batch reset signal is applied. Batch output is not affected by **RST** key in front and external reset signal.

### Change of Batch preset value

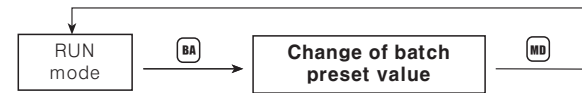

- If press **BA** key at RUN mode, it will move to the state of batch preset value changes. After changing the batch preset value same as the method of Counter preset value changes by **←**, **↓**, **↑** keys, it will move to RUN mode by pressing **MD** key. When it moves to the state of batch preset value, the previous batch counting value will be displayed.
- If change the batch preset value equal or smaller than the batch counting value in state of batch preset value is larger than batch counting value, batch output will be ON.
- If batch preset value is "0" (ZERO), Batch output will be OFF state.
- If no key is touched for 60second after moved to state of batch preset value changes, it will return to RUN mode.

## How to set Lock key

Be sure to set the lock mode in order to protect malfunction by unauthorized key touched.

**LoFF** (LOCK OFF) : Cancellation of the lock mode

**LoL1** (LOCK LEVEL 1) : Lock **RST** key

**LoL2** (LOCK LEVEL 2) : Lock **←** & **↓** & **↑** key

**LoL3** (LOCK LEVEL 3) : Lock **RST** & **←** & **↓** & **↑** key

## Prescale function

This function is to set and indicate calculated unit for actual length, liquid measure, position etc. it is called "Prescale value" for measured length, measured liquid, measured position, etc per 1 pulse.

For example) Pulse number P is number of pulses per 1 revolution of rotary encoder. L is the desired length to be measured. Prescale value is desired length L/pulse number P generated by the rotary encoder. It is the length measured per 1 pulse.

### Control length by the counter and the rotary encoder

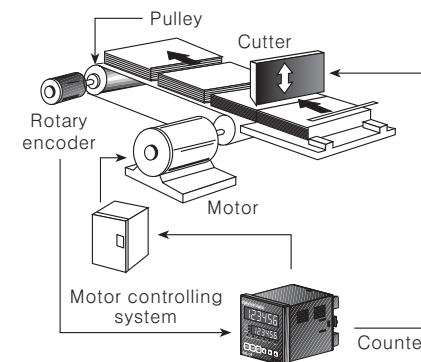

$$\begin{aligned} \text{Prescale value} &= \frac{\pi \times \text{Diameter of the Pulley}(D)}{\text{Pulse numbers per 1 revolution of the encoder}} \\ &= \frac{3.1416 \times 22}{1000} \\ &= 0.069\text{mm/pulse} \end{aligned}$$

It is possible to control conveyor as 0.1mm unit to set 0.069 for Prescale value by pressing setting key in state of prescale value setting in function setting mode. Decimal point should be set the first decimal place in function setting mode.

[Diameter of the Pulley connected with the encoder is 22mm, pulse number of encoder per 1revolution:1000]

## Error code display

Error display	Errors	Output status	How to return
Err 1	CPU error	Double preset type:OUT1, OUT2 are OFF Single preset type:OUT is OFF	<b>RST</b> key, RESET input

## Factory specification

Set item	Model	Double preset model (CT6-2P)	Single preset model (CT6)	Indicator model (CT6-1)
COUNTER	Input mode	Up/Down-C(U/D-C)		
	Output mode	F		
	OUT1	100ms		
	OUT2(OUT)	Hold		
	CPS	30cps		
	Min. reset time	20ms		
	Decimal point	Non decimal point		
TIMER	Prescale value	1.000		
	Counting memory	CLER(Power reset)		
	Time range	0.01s-9999.99s		
	Up/Down mode	U(UP)		
	Output mode	OND(ON Delay)		
	Output time	Hold		
	Input signal mode	20ms		
Input method	No-voltage input(NPN)			
Lock key	L.oFF(Lock OFF)			
Counter/Timer	Counter			

## Change of operation mode(Counter/Timer)

### Operation mode in Counter

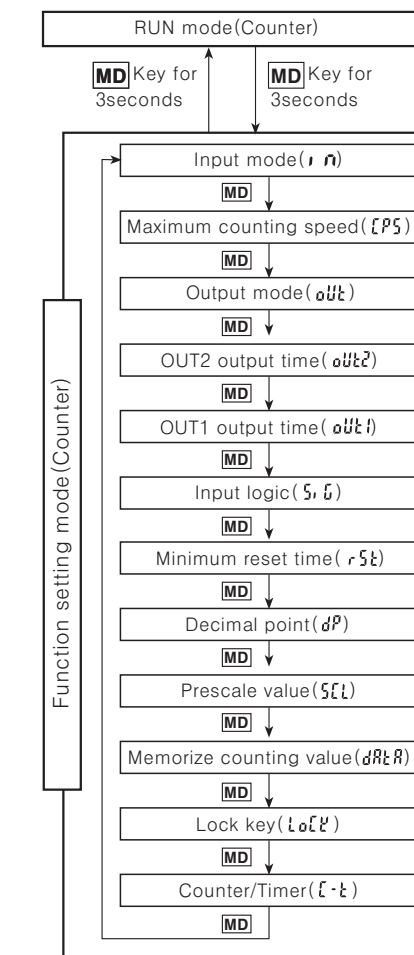

### Operation mode in Timer

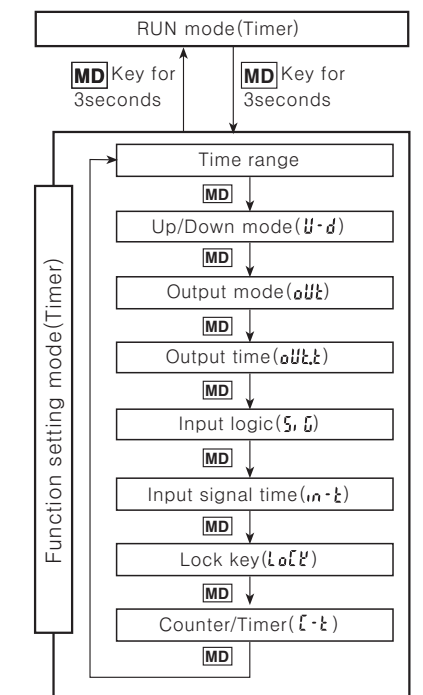

※After selecting Timer in Counter/Timer of Counter function setting mode, if press **MD** for more than 3sec., it will move to Timer RUN mode. After select Counter in Counter/Timer of Timer function setting mode, if press **MD** for more than 3sec., it will move to Counter RUN mode. ※If press **MD** for more than 3sec. in RUN mode, it will move to function setting mode. If press **MD** for more than 3sec. in function setting mode, it will move to RUN mode. If no key touched more than 60sec., it will move to RUN mode.

## Setting of counter function modes

Setting mode	How to set (▲, ▼)
Input mode (r n)	U → d → Ud-A → Ud-b → Ud-C Ud-A, B, C will be fixed in the input mode, if output mode is S, T, D.
Maximum counting speed (CP5)	1 → 30 → 1K → 5K → 10K Counting speed is that of one by one (1:1) duty ratio of INA or INB input signal, and it is applied in INA or INB at the same time. In case of setting D in output mode, 5kcps and 10kcps are not indicated in the display.
Output mode (OUT)	*Up or Down input mode F → n → C → r → U → P → Q → A *Up/Down-A, B, C input mode F → n → C → r → U → P → Q → A → S → T → D
OUT2 output time (OUT2)	10 → 50 → 100 → 200 → 500 → 1000 → 2000 → 5000 Unit:ms
OUT2 output time (OUT1)	10 → 50 → 100 → 200 → 500 → 1000 → 2000 → 5000 → Hold Unit:ms
Input logic (S, D)	It indicates according to position, and it can't set by ▲ & ▼ key. Voltage input : PnP No-voltage input : nPn
Min. reset time (r5t)	1 → 20 Min. external RESET signal width (Unit:ms)
Decimal point (dP)	-----*-----*-----*
Prescale value (SC)	Key : Shift the flickering digit ▲, ▼ Key : Change the prescale value Set range of prescale value : 0.001 to 99.999 Prescale value : It is actual value of length and position, liquid measure from counting input of 1pulse
Memorize counting value (dRtA)	CLER : Power reset for counting value. (Reset counting value when power off) CLER ↔ rEC rEC : Memorize counting value (Memorize counting value when power off)
Lock key (LoL)	L.off → LoL.1 → LoL.2 → LoL.3
Counter/Timer (C-t)	LoLn ↔ t, nE LoLn : Counter t, nE : Timer

## Input operation mode for counter

\*▲:Over Min. signal width, ②:Over 1/2 of Min. signal width

Input mode	Counting chart	Notice
U (Up)		INA : Counting input INB : No counting input (Limit counting input of INA) *When INA is L, please set no counting (INA:H → L) or turn off no counting (INB:L → H)
d (Down)		INA : No counting input (Limit counting input of INB) INB : Counting input
d (Up/Down-A)		When INB is H, please set no counting (INA:H → L) or turn off no counting (INB:L → H)
d (Up/Down-B)		INA : Counting value input (Limit counting input of INA) INB : No counting input n=Preset value When INA is L, please set no counting (INA:L → H) or turn off no counting (INB:H → L)
Ud-A (Up/Down-A)		INA : No counting input (Limit counting input of INB) INB : Counting input N=preset value When INA is L, please set no counting (INA:H → L) or turn off no counting (INB:L → H)
Ud-b (Up/Down-B)		INA : Counting value input INB : Up/Down counting command input When INB is L, counting Up When INB is H, counting Down
Ud-C (Up/Down-C)		INA : Counting Up input INB : Counting Down input When INA and INB applied L → H, it will remain previous counting value.

\*When use A, B phase of encoder with connecting to INA, INB, please set counter input mode as phase different input (Ud-C).

Symbol	Input type	Voltage input (PNP)	Contact input (NPN)
H		5-30VDC	Short circuit
L		0-2VDC	Open

## Output operation mode for counter

One-shot output (OUT1 output)    One-shot output (OUT2 output)    Hold output    Coincidence output

Output mode	Input mode	Operation
F (F)	Up, Down, Up/Down A, B, C	After counting up, the display value increases or decreases until the reset signal is applied, and hold outputs will be held. One-shot output of OUT1 operates regardless to OUT2.
N (N)	Up, Down, Up/Down A, B, C	After counting up, display value and hold output will be held until reset signal is applied. One-shot output of OUT1 operates regardless to OUT2.
C (C)	Up, Down, Up/Down A, B, C	The display value resets at the same time counting up. Hold output of OUT1 turns off after One-shot time of OUT2. One-shot output of OUT1 operates regardless to OUT2.
R (R)	Up, Down, Up/Down A, B, C	After one shot time of OUT2, display value will be reset and counting operation starts again. Hold output of OUT1 turns off after One-shot time of OUT2. One-shot output of OUT1 operates regardless to OUT2.
K (K)	Up, Down, Up/Down A, B, C	After counting up, the display value increases or decreases until the reset signal is applied. Hold output of OUT1 turns off after One-shot time of OUT2. One-shot output of OUT1 operates regardless to OUT2.
P (P)	Up, Down, Up/Down A, B, C	After counting up, display value is held for One-shot time of OUT2, Counter operation start again at the same time of OUT2 output is ON and count value will be reset. Hold output of OUT1 turns off after One-shot time of OUT2. One-shot output of OUT1 operates regardless to OUT2.
Q (Q)	Up, Down, Up/Down A, B, C	After counting up, display value increases or decreases for One-shot time of OUT2. Hold output of OUT1 turns off after One-shot time of OUT2. One-shot output of OUT1 operates regardless to OUT2.
A (A)	Up, Down, Up/Down A, B, C	After counting up, display value and Hold output of OUT1 is held until applying the reset signal. One-shot output of OUT1 operates regardless to OUT2. OUT2 returns automatically after one shot time.
S (S)	Up/Down - A, B, C	OUT1 and OUT2 keeps ON state in following condition: Display value ≥ Preset 1 Display value ≥ Preset 2
t (t)	Up/Down - A, B, C	OUT1 keeps OFF state when display value is smaller than Preset 1 value, but if Preset 2 is "0", OUT1 keeps ON state. OUT2 keeps ON state when display value is equal or larger than Preset 2.
d (d)	Up/Down - A, B, C	When display value is equal to set value (Preset 1 or Preset 2) only, OUT1 or OUT2 output keeps ON state. When set 1kcps for counting speed, solid state contact output should be used.

\*Output of single preset type is operating the same as OUT2 of double preset type.

## Counter operation of CT6-I (Indication only)

<p>●In case of input mode is Up</p>	<p>●In case of input mode is Down</p>
<p>●In case of the input mode is command input (Ud-A), Individual input (Ud-b), Phase difference input (Ud-C)</p>	

\*There is no "OUT1 output time" in single preset model (CT6), "OUT2 output time" will be replaced as "OUT output time (OUT.t)".

\*In case of setting output mode as "F, N", if counting value reach at preset value, output will be held. So there is no "OUT2 output time" in function setting mode.

\*If set "S, T, D" as the output mode, input will fixed one from Ud-A, Ud-B, Ud-C.

If change input mode to Up/Down, it needs to change an other mode, not "S, T, D"

\*When it is in function setting mode, no external input signal will be accepted and the output will stay in the OFF state.

\*When selecting the "D" output mode and if 1kcps is used, the output may not operate normally because of respond time of the contact. Therefore, in this case be sure to use the solid state output.

\*In state of maximum counting speed is 5kcps or 10kcps, if change output mode to "D", the maximum counting speed will be changed to 1cps.

\*It will maintain OFF status to ignore output in function setting mode.

\*There are no output mode and output time setting mode of function setting mode in CT6-I series.

## Setting of timer function modes

Set menu	How to set (▲, ▼)
Time range	
UP/DOWN mode (U-d)	<p>Up : Time proceeds from 0(zero) to the set value Down : Time proceeds from the set value to 0(zero)</p>
Output mode (oUt)	
Output time (oUt.t)	<p>It is operation time of control output according to output mode.</p>
Input logic (S, U)	It indicates according to position, and it can't set by ▲ & ▼ key. Voltage input : PnP No-voltage input : nPn
Input signal time (in-t)	1 -> 20 (Unit:ms) Selection of Min. signal width of INA, INHIBIT, RESET, BATCH RESET signal
Lock key (Lock) (LoLk)	L.oFF -> LoL.1 -> LoL.2 -> LoL.3
COUNTER/TIMER (C-t)	CoUn -> t, nE CoUn : COUNTER t, nE : TIMER

When setting the function mode, no external input signal will be accepted and the output will stay in the OFF state.  
 \*In case of output mode is FKL, INT, INT1, OFD, there is no output time setting in the function setting mode.  
 \*In the indicator type(CT6-I), there are no the output mode and the output time in the function setting mode (OUT1, OUT2).  
 \*Control output operates as OUT2 in the double preset type(CT6-2P), and OUT1 always keeps "OFF" status.  
 \*When in the function setting mode, if no key is touched for 60 sec. the timer will return to RUN mode.

## Time range(CT6-2P, CT6, CT6-I)

Time range	Function setting mode	
	Counting display	Preset display
0.01s - 9999.99s	SEC	9999.99
0.1s - 99999.9s	SEC	99999.9
1s - 999999s	SEC	999999
0.01s - 99m59.99s	n S	9959.99
0.1s - 999m59.9s	n S	9995.99
0.1m - 99999.9m	n	99999.9
1m - 999999m	n	999999
1s - 99h59m59s	H n S	995959
1m - 9999h59m	H n	999959

## Output operation mode(Timer)

Output mode	Time chart	Operation
ond (OND)		1)Time starts when INA signal turns on, if INA signal turns off, time resets. 2)Time starts when power turns on and when reset turns off during INA signal on. 3)Control output operates as hold or One-shot time.
		1)Time starts when INA signal turns on, if INA signal is applied repeatedly, only initial signal is applied. 2)Time starts when power turns on and when reset turns off during INA signal on. 3)Control output operates as hold or One-shot time.

ond.2 (OND.2)		1)Time starts when power turns on. (There is no INA function) 2)Time resets when reset turns on. Time starts when reset turns off. 3)Control output operates as hold output or One-shot output. 4)It memorizes display value when power turns off.
		1)Time starts when INA signal turns on, if INA signal is applied repeatedly, only initial signal is applied. 2)Time starts when power turns on and when reset turns off during INA signal on. 3)Control output operates as hold output, turns on for the Toff time and turns on for the Ton time repeatedly. (There is no One-shot output) 4)Each the Ton time and the Toff time must be set individually. 5)In case of using the contact output, Min. setting time must be set over 100ms.
FLK (FLK)		1)Time starts when INA signal turns on, if INA signal is applied repeatedly, only initial signal is applied. 2)Time starts when power turns on and when reset turns off during INA signal on. 3)Control output operates as hold output, turns on for the Toff time and turns on for the Ton time repeatedly. (There is no One-shot output) 4)Each the Ton time and the Toff time must be set individually. 5)In case of using the contact output, Min. setting time must be set over 100ms.
		1)Time starts when INA signal turns on, if INA signal is applied repeatedly, only initial signal is applied. 2)Time starts when power turns on and when reset turns off during INA signal on. 3)Control output operates as One-shot, in case of using the contact output, Min. setting time must be set over 100ms.
FLK.1 (FLK.1)		1)Time starts when INA signal turns on, if INA signal is applied repeatedly, only initial signal is applied. 2)Time starts when power turns on and when reset turns off during INA signal on. 3)Control output operates as hold output, turns on for the Toff time and turns on for the Ton time repeatedly. (There is no One-shot output) 4)Each the Ton time and the Toff time must be set individually. 5)In case of using the contact output, Min. setting time must be set over 100ms.
		1)Time starts when INA signal turns on, if INA signal is applied repeatedly, only initial signal is applied. 2)Time starts when power turns on and when reset turns off during INA signal on. 3)Control output operates as One-shot output when reaches to the set time. 4)In case of using the contact output, Min. setting time must be set over 100ms.
FLK.2 (FLK.2)		1)Time starts when INA signal turns on, if INA signal is applied repeatedly, only initial signal is applied. 2)Time starts when power turns on and when reset turns off during INA signal on. 3)Control output operates as hold output, turns on for the Toff time and turns on for the Ton time repeatedly. (There is no One-shot output) 4)Each the Ton time and the Toff time must be set individually. 5)In case of using the contact output, Min. setting time must be set over 100ms.
		1)Time starts when INA signal turns on, if INA signal is applied repeatedly, only initial signal is applied. 2)Time starts when power turns on and when reset turns off during INA signal on. 3)Control output operates as One-shot output when reaches to the set time. 4)In case of using the contact signal, Min. setting time must be set over 100ms.
INT (INT)		1)When INA is ON, time starts. 2)When INA is OFF, time resets. 3)Time starts when power turns on and when reset turns off during INA signal turns on. 4)When time reaches to set value, display value and control output will be reset automatically. 5)Control output turns ON, during time processes.
		1)Control output turns on and time starts when INA signal turns on. 2)If INA signal is applied repeatedly, only initial signal is applied. 3)When reaches to set value, display value and control output is reset automatically. 4)Time starts when power turns on and when reset turns off during INA signal turns on. 5)Time processes normally while INA signal keeps ON status.

INT.1 (INT.1)		1)Control output turns on and time starts when INA signal turns on. 2)If INA signal is applied repeatedly, only initial signal is applied. 3)When reaches to set value, display value and control output is reset automatically. 4)Time starts when power turns on and when reset turns off during INA signal turns on. 5)Time processes normally while INA signal keeps ON status.
		1)If power is on and reset is off, control output keeps on state during INA signal is ON. 2)When time reaches to set value, display value and control output will be reset automatically.

\*POWER RESET : There is no memory retention. (Initialize the indicating value)  
 \*POWER HOLD : There is memorizes retention. (It memorizes the indicating value when power cut off and displays the value as initial value)

## Timer operation of CT6-I(Indication only)

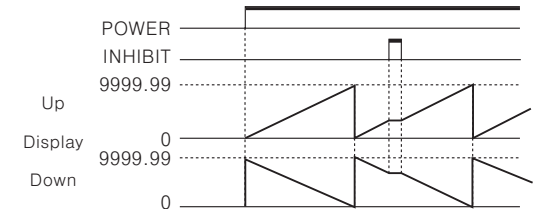

## Caution

- The power ON/OFF
    - Power voltage rises for 100ms after power on and falls for 700ms after power off. Therefore be sure to apply input signal after 100ms and power turns on again after 700ms when power turns off.
    - When apply the power into CT series, please apply the power in an instant by using Switch or Relay.
  - Input signal line
    - Use as short a cable from the sensor to this unit as possible.
    - Use shielded cable for long input line.
    - Wire as separating input line from the power line.
  - Contact count input (When it is used as Counter)
    - If apply contact input at high speed mode(1k, 5k, 10k), it may miscount by chattering. Therefore set low speed mode(1 or 30cps) at contact input.
  - When test dielectric voltage and insulation resistance of the control panel with this unit installed.
    - Please isolate this unit from the circuit of control panel.
    - Please make all terminals of this unit short-circuited.
  - Do not use below places.
    - Place where there are severe vibration or impact
    - Place where strong alkalis or acids are used.
    - Place where there are direct ray of the sun
    - Place where strong magnetic field or electric noise are generated.
  - Installation environment
    - It shall be used indoor
    - Altitude Max. 2000m
    - Pollution Degree 2
    - Installation Category II
- \* It may cause malfunction if above instructions are not followed.**

## Main products

- COUNTER
- TIMER
- TEMPERATURE CONTROLLER
- PANEL METER
- TACHO/LINE SPEED/PULSE METER
- DISPLAY UNIT
- PROXIMITY SENSOR
- PHOTOELECTRIC SENSOR
- FIBER OPTIC SENSOR
- PRESSURE SENSOR
- ROTARY ENCODER
- SENSOR CONTROLLER
- POWER CONTROLLER
- STEPPING MOTOR & DRIVER & CONTROLLER
- LASER MARKING SYSTEM

**Autonics Corporation**  
<http://www.autonics.net>

■ HEAD QUARTER :  
 41-5, Yongdang-ri, Ungsang-eup, Yangsan-si, Gyeongnam, Korea 626-847  
 ■ INTERNATIONAL SALES :  
 512 Ansong B/D, 410-13, Shindorim-dong, Guro-gu, Seoul, Korea 152-070  
 TEL:82-2-2679-6585 / FAX:82-2-2679-6556  
 ■ E-mail : sales@autonics.net