

11 in 1 Environmental Meter

Models EN150 and EN100

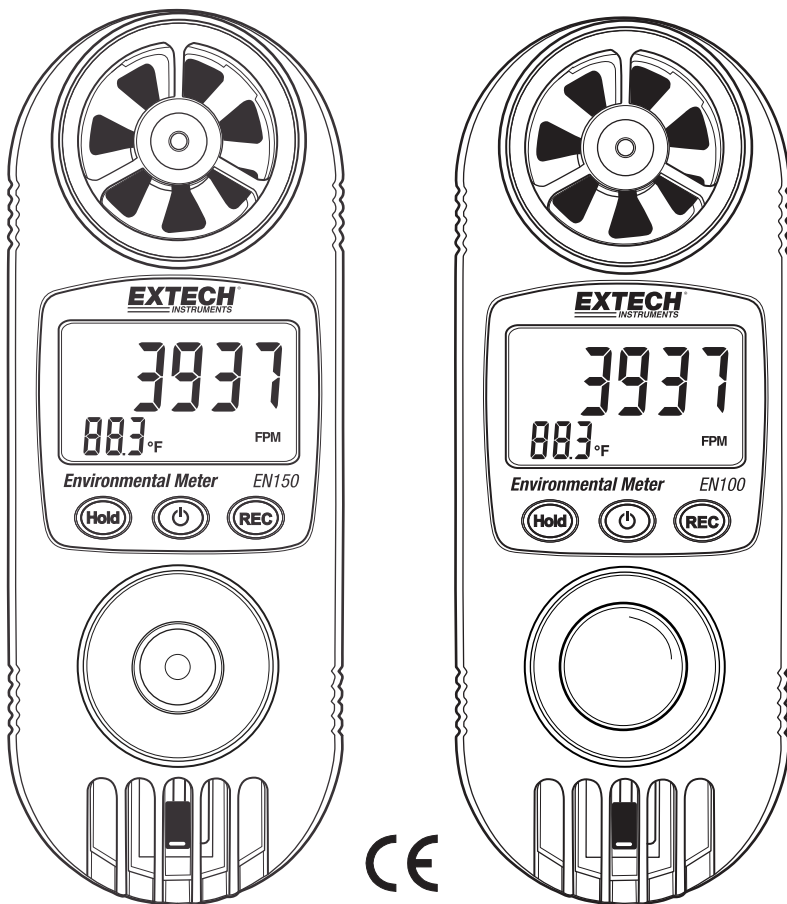

Introduction

Congratulations on your purchase of this Extech Meter. The EN100 or EN150 contains 11 professional meters built into one convenient package. This meter ships fully tested and calibrated and, with proper use, should provide many years of reliable service.

Features

This 11-in-1 professional measuring instrument provides the following functions:

1. Anemometer uses a low-friction ball bearing mounted wheel design for high accuracy
2. Humidity meter uses a high Precision humidity sensor for fast response time
3. Light meter uses a photo diode and color correction filter light sensor; spectrum meets C.I.E. photopic (EN100 only). The EN150 has a UV Light sensor
4. Optional PT1000 RTD probe for external temperature measurements (EN100-TP)

Common Features

- Built-in microprocessor circuit assures excellent performance and accuracy
- Concise and compact button arrangement for ease of operation
- Maximum and minimum values
- Hold function freezes the current reading value
- Front panel °C / °F selection button
- Lux/Foot-candle selection button
- Five (5) air velocity measurement units, selected by a front panel button
- Dual display with simultaneous display of relative humidity and temperature or air velocity and temperature
- Automatic Zero for the light meter
- Measurement capabilities for: Air Velocity, Air Flow, Wind Chill, Humidity, Dew Point, Wet Bulb, Heat Index, Light (Visible – EN100) (UVA – EN150), Thermometer, Barometric Pressure, Altitude

Safety

International Safety Symbols



This symbol, adjacent to another symbol or terminal, indicates the user must refer to the manual for further information.



Double insulation

Cautions

- Improper use of this meter can cause damage, shock, injury or death. Read and understand this user manual before operating the meter.
- Inspect the condition of the probe and the meter itself for any damage before operating the meter. Repair or replace any damage before use.
- If the equipment is used in a manner not specified by the manufacturer, the protection provided by the equipment may be impaired.
- This device is not a toy and must not reach children's hands. It contains hazardous objects as well as small parts that the children could swallow. In case a child swallows any of them, please contact a physician immediately
- Do not leave batteries and packing material lying around unattended; they can be dangerous for children if they use them as toys
- In case the device is going to be unused for an extended period of time, remove the batteries to prevent them from draining
- Expired or damaged batteries can cause cauterization on contact with the skin. Always, therefore, use suitable hand gloves in such cases
- See that the battery is not short-circuited. Do not throw batteries into the fire.

Meter Description

1. Air Speed Sensor
2. PT1000 RTD probe input socket (optional)
3. LCD Display
4. Hold Button
5. REC button
6. Power Button
7. Light Sensor (EN100); UV Sensor (EN150)
8. Air Temperature and Relative Humidity sensor

Note: Altitude sensor and battery compartment on rear of unit

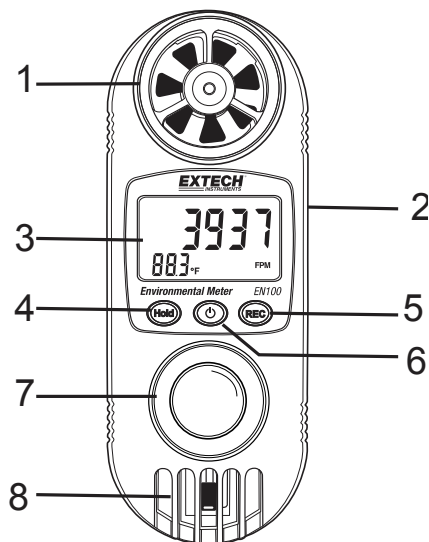

Units of Measure Selections

Units	Function
An	Anemometer: ft/min, m/s, km/h, MPH, knots; Temp °C/ °F
AirFl	Air flow: CFM, CMM
CHILL	Wind Chill: °C/ °F
rH	Relative Humidity: %RH; Temp: °C/ °F
dP	Dew Point: °C/ °F
_Et	Wet Bulb Temperature: °C/ °F
HEAt	Heat Index: °C/ °F
Light	Visible light: Lux, Ft-cd (EN100 only)
U A	UVA light: uW/cm ² , mW/cm ² (EN150 only)
BAr	Barometric pressure: mmHg, hPA, inHg
High	Altitude: Ft, m
Pt	Optional RTD probe (PT1000)

Operation

Powering the meter

1. Press the Power button to turn the instrument ON
2. If the meter does not turn on or if the "☒☒" low battery symbol appears in the display, replace the batteries.
3. Press the Function button to select the measurement needed.
4. Press and hold the Power button for >4 seconds to power off the unit.

Anemometer - Air Velocity Measurement

1. Select the Air Velocity function by pressing and holding the "HOLD" button until the display indicates "An" and then release the HOLD button.
2. Press and Hold the "REC" button until 'Units' appears. Press the Power button (up) or the Hold button (down) to select the desired units; Anemometer units (ft/min, m/s, km/h, MPH, or knots).
3. Press "REC" to select the temperature unit. C/F
4. Press the REC button again to return to the Air velocity measurement mode.
5. Face the air velocity sensor into the source of the airflow.
6. The display will show the air velocity and the ambient temperature.
7. Allow time for the reading to stabilize and note the values indicated.

Anemometer - Air Flow Measurement

1. Select the Air Flow function by pressing and holding the "HOLD" button until the display indicates "AirFl" then release the HOLD button.
2. Press and Hold the "REC" button until 'Units' appears. Press the Power button (up) to select CFM or CMM. Press the REC button to save the units.
3. To Enter the Square area of a duct, press the HOLD button momentarily. The HOLD icon will appear on the display. Press and hold the "REC" button until m-2 or F-2 appear in the lower left corner of the display. Use the Power (up) or HOLD button (down) to enter a Square area value. Press the "REC" button to save.
4. Face the air velocity sensor into the source of the airflow.
5. The display will show the Air Flow measurement.
6. Allow time for the reading to stabilize and note the values indicated. Air velocity may fluctuate slightly.

Wind Chill Measurement

1. Select the Wind Chill function by pressing and holding the "HOLD" button until the display indicates "CHILL" then release the HOLD button.
2. Press and Hold the "REC" button until dCcf appears. Press the Power button (up) to select C or F. Press the REC button to save the units.
3. Face the air velocity sensor into the source of the airflow.
4. The display will show the Wind Chill temperature.
5. Allow time for the reading to stabilize and note the values indicated. Air velocity may fluctuate slightly.

Note: In order to obtain accurate measurements for Air Temperature, RH, Dew point, Wet bulb, Wind Chill, and Heat Index, keep hands and fingers away from the sensor area at the bottom of the meter.

Humidity & Ambient Temperature Measurement

1. Select the Relative Humidity function by pressing and holding the "HOLD" button until the display indicates "rH" then release the HOLD button.
2. The humidity and air temperature readings will display on the LCD.
3. Allow several minutes of stabilization time to elapse each time the meter takes measurements in a new location.
4. To reverse the display, press the HOLD button for less than 1 second; 'HOLD' will appear on the display, press the Power button and the display will be reversed. Repeat the procedure to revert the display's orientation.

Note: In order to obtain accurate measurements for Air Temperature, RH, Dew point, Wet bulb, Wind Chill and Heat Index, keep hands and fingers away from the sensor area (8) at the bottom of the meter.

Dew Point Measurement

1. Select the Dew Point function by pressing and holding the "HOLD" button until the display indicates "dP" then release the Hold button.
2. Press and Hold the "REC" button until dCcf appears. Press the Power button (up) to select C or F. Press the REC button to save the units.
3. The Dew point temperature reading will display on the LCD in C or F units.
4. Allow several minutes of stabilization time to elapse each time the meter takes measurements in a new location.
5. To reverse the display, press the HOLD button for less than 1 second; 'HOLD' will appear on the display, press the Power button and the display will be reversed. Repeat the procedure to revert the display's orientation.

Wet Bulb Measurement

1. Select the Wet Bulb function by pressing and holding the "HOLD" button until the display indicates "**_Et**" then release the Hold button.
2. Press and Hold the "REC" button until dCcf appears. Press the Power button (up) to select C or F units. Press the REC button to save the units.
3. The Wet bulb temperature reading will display on the LCD in C or F units.
4. Allow several minutes of stabilization time to elapse each time the meter takes measurements in a new location.
5. To reverse the display, press the HOLD button for less than 1 second; 'HOLD' will appear on the display, press the Power button and the display will be reversed. Repeat the procedure to revert the display's orientation.

Note: In order to obtain accurate measurements for Air Temperature, RH, Dew point, Wet bulb, Wind Chill and Heat Index, keep hands and fingers away from the sensor area (8) at the bottom of the meter.

Heat Index Measurement

1. Select the Heat Index function by pressing and holding the "HOLD" button until the display indicates "**HEAt**" and then release the Hold button.
2. Press and Hold the "REC" button until dCcf appears. Press the Power button (up) to select C or F units. Press the REC button to save the units.
3. The Heat Index temperature reading will display on the LCD in C or F units.
4. Allow several minutes of stabilization time to elapse each time the meter takes measurements in a new location.
5. To reverse the display, press the HOLD button for less than 1 second; 'HOLD' will appear on the display, press the Power button and the display will be reversed. Repeat the procedure to revert the display's orientation.

Note: In order to obtain accurate measurements for Air Temperature, RH, Dew point, Wet bulb, Wind Chill and Heat Index, keep hands and fingers away from the sensor area (8) at the bottom of the meter.

Light Measurement – Visible Light (EN100 only)

1. Select the Light Measurement function by pressing and holding the "HOLD" button until the display indicates "**Light**" then release the HOLD button.
2. Press and hold the "REC" button until 'Units' appears. To switch between "Lux" or "Ft-cd" press the Power button. Press REC to exit and return to the Light measurement mode; the selected Unit (Lux or Ft-cd) will be displayed.
3. The Display will reverse and will show the light illuminance value in Lux or Ft-cd.

Light Measurement – UV Light (EN150 only)

1. Select the UVA Light Measurement function by pressing and holding the "HOLD" button until the display indicates "**U A**" and then release the HOLD button.
2. The display will read the value of UVA light in either mW/cm² or uW/cm². The unit of measure is not selectable here.
3. The Display will reverse and show the light illuminance value in mW/cm² or uW/cm².
4. To reverse the display, press the HOLD button for less than 1 second; 'HOLD' will appear on the display, press the Power button and the display will be reversed. Repeat the procedure to revert the display's orientation.

Altitude Measurement

1. Select the Altitude Pressure function by pressing and holding the "HOLD" button until the display indicates "**High**" then release the HOLD button.
2. Select the altitude units by pressing "REC" button until the display shows 'units'. Press the Power button to change the units and then press "REC" button to save. Units are Ft (feet) and m (meters).
3. The display will read the altitude.

Note: For an accurate Altitude measurement you can

- Enter a known altitude.
 - Enter the Sea level barometric pressure setting.
- a. Set the known value for altitude.
 - Power ON the meter and set it to read Altitude (High).
 - Set the Units of measure to Ft or m.
 - Press the HOLD button once, 'hold' will appear on the display. Press the REC button, the display will show either Ft or m units.
 - Using the Power (up) or Hold (down) buttons, set the value to the known altitude. Press the REC button to save the value.
 - b. Set the known Sea level barometric pressure (check a local Airport)
 - Select the Barometric Pressure function by pressing and holding the "HOLD" button until the display indicates "**bAr**" and then release the HOLD button.

- Select the preferred pressure units by pressing "REC" button until the display shows units. Press the Power button to change the units to hPa and then press "REC" button to save. (mBar = hPa)
- Select the Altitude function by pressing and holding the "HOLD" button until the display indicates "**High**" and then release the HOLD button.
- Press the HOLD button once, 'hold' will appear on the display. Press the REC button for more than 3 seconds, the display will show either hPa, mmHg or inHg.
- Using the Power (up) or Hold (down) buttons, set the value to the known sea level barometric pressure. Press the REC button to save the value.

Barometric Pressure Measurement

1. Select the Barometric Pressure function by pressing and holding the "HOLD" button until the display indicates "**bAr**" and then release the HOLD button.
2. Select the pressure units by pressing "REC" button until the display shows 'units'. Press the Power button to change the units and then press "REC" button to save. The available units are hPa, mmHg, and inHg.
3. The display will read the actual air pressure.

Note: Altitude and Air Pressure affect the actual Air pressure measurement.

4. To view the Sea level Barometric pressure, follow this procedure
 - a. Press the HOLD button once, 'hold' will appear on the display. Press the REC button for more than 3 seconds, the display will show either Ft or m units.
 - b. Using the Power (up) or Hold (down) buttons, set the value to the known actual altitude value. Press the REC button to show the Sea level pressure.

Note: After powering OFF and then ON, the pressure reading will read actual barometric pressure.

Temperature Measurement (Optional RTD probe)

1. Plug the optional, PT1000 RTD probe into the "RTD Input Socket".
2. Select the External Temperature function by pressing and holding the "HOLD" button until the display indicates "**Pt**" and then release the HOLD button.
3. Select the temperature units by pressing the "REC" button until the display shows 'units'. Press the Power button to change the units and then press the "REC" button to save (°C or °F).
4. Touch the RTD probe to the surface under test.
5. The temperature value will display on the LCD display.

Hold Function

Press the "Hold Button" to freeze the current reading value, the "HOLD" symbol appears on the display. Press the button again to return to normal operation.

Data Record Function

1. The Record function captures & displays the Maximum and Minimum reading values.
Start the Data Record function by pressing the "REC" button once. The "REC" symbol appears on the display.
2. With the REC symbol on the display :
 - a. Press the "REC" button once and the "Max" symbol along with the maximum value will appear on the display.
 - b. Press the "REC" button again; the "Min" symbol along with the minimum value will appear on the display.
 - c. To exit the Data Record function, press and hold the "REC" button for at least 2 seconds. The display will revert to the current reading and the Max/Min values will clear.

Auto Power-off

To prolong the life of the batteries, the instrument has an "Auto Power-off" function. The meter will automatically switch off if there are no button presses in any 10-minute period. To disable the Auto OFF feature, start Data Record as outlined above.

Battery Replacement

1. When the LCD display shows the "" symbol, it is necessary to replace the battery. However, the meter will work accurately for several hours after the low battery indicator appears.
2. Remove the battery cover by turning the cover counter-clockwise 1/8 of a turn.
3. Install a fresh CR2032 battery (3VDC) and then securely affix the cover.



Never dispose of used batteries or rechargeable batteries in household waste. As consumers, users are legally required to take used batteries to appropriate collection sites, the retail store where the batteries were purchased, or wherever batteries are sold.

Disposal: Do not dispose of this instrument in household waste. The user is obligated to take end-of-life devices to a designated collection point for the disposal of electrical and electronic equipment.

Other Battery Safety Reminders

- Never dispose of batteries in a fire. Batteries may explode or leak.
- Never mix battery types. Always install new batteries of the same type

Specifications

General Specifications

Display	LCD display, 18 x 32mm (0.7 x 1.6")
Measurements	Air Velocity, Air Flow, Wind Chill, Humidity, Dew Point, Wet Bulb, Heat Index, Light (Visible – EN100; UVA – EN150), Thermometer, Barometric Pressure, and Altitude
Operating Humidity	80%RH Max.
Operating Temperature	0 to 50°C (32 to 122°F)
Over Input Display	Indication of "- - -"
Power Supply	CR2032 battery, DC 3V
Power Consumption	Approx. DC 5 mA
Weight	160 g (0.35 lbs.) with battery installed
Dimension	HWD 120 x 45 x 20 mm (4.7 x 1.8 x 1.2")

Electrical Specifications

Anemometer (Air velocity/Temperature)

Units	Range	Res.	Accuracy
ft/min	80 to 3937 ft/min	1	± 3% F.S.
m/s	0.4 to 20.0 m/s	0.1	
km/h	1.4 to 72.0 km/h	0.1	
MPH	0.9 to 44.7 mile/h	0.1	
knots	0.8 to 38.8 knots	0.1	
°F	32 to 122°F	0.1	± 2.5°F
°C	0 to 50°C	0.1	± 1.2°C

Air Flow

Units	Range	Resolution
CFM	0.847 to 1271300	0.001/0.01/0.1/1/10(x10)/100(x100)
CMM	0.024 to 36000	0.001/0.01/0.1/1

Humidity/Temperature

Units	Range	Resolution	Accuracy
%RH	10 to 95 %RH	0.1	< 70 %RH : ± 4 %RH ≥ 70 %RH : $\pm (4\%rdg + 1.2\%RH)$
°F	32 to 122°F	0.1	± 2.5 °F
°C	0 to 50°C	0.1	± 1.2 °C

Dew Point Temperature

Units	Range	Resolution	Accuracy
°F	-13.5 to 120.0	0.1	Calculated from %RH and temperature
°C	-25.3 to 49.0	0.1	

Wet Bulb Temperature

Units	Range	Resolution	Accuracy
°F	22.2 to 120.0	0.1	Calculated from %RH and temperature
°C	-5.4 to 49.0	0.1	

Wind Chill

Units	Range	Resolution	Accuracy
°F	15.0 to 112.0	0.1	± 3.6
°C	-9.4 to 44.2	0.1	± 2.0

Heat Index

Units	Range	Resolution	Accuracy
°F	32 to 212.0	0.1	± 3.6
°C	0 to 100	0.1	± 2.0

Barometric Pressure

Units	Range	Resolution	Accuracy
hPa	10 to 999.9	0.1	± 1.5 hPa
	1000 to 1100	1	± 2 hPa
mmHg	7.5 to 825.0	0.1	± 1.2
inHg	0.29 to 32.48	0.01	± 0.05

Altitude

Units	Range	Resolution	Accuracy
m	-2000 to 9000	1	± 15
Ft	-6000 to 30000	1	± 50

Visible Light (EN100 only)

Units	Range	Resolution	Accuracy
Lux	0 to 2,200 Lux	1	± 5% rdg ± 8 digits
	1,800 to 20,000 Lux	10	
Ft-cd	0 to 204.0 Fc	0.1	
	170 to 1,860 Fc	1	

UVA Light (EN150 only) (band pass 290nm to 390nm)

Units	Range	Resolution	Accuracy
uW/cm ²	0 to 1999	1	±(4%Full Scale + 2 digits)
mW/cm ²	2 to 20.00	0.01	

RTD Thermometer

Units	Range	Resolution	Accuracy
°F	14 to 158	1	± 2.5
°C	-10 to 70	1	± 1.2

Note: The EN100-PT RTD probe is optional

Copyright © 2014-2015 FLIR Systems, Inc.

All rights reserved including the right of reproduction in whole or in part in any form

ISO-9001 Certified

www.extech.com