

Quick Disconnection Type

Cylindrical connector type proximity sensor

■ Features

- Enhanced noise-resistance by using exclusive IC (DC power)
- Upgraded DC2-wire type :
Residual voltage (Max. 4VDC), Control output range (2~100mA),
Operation voltage (10~30VDC)
- Polarity free DC2-wire type
- Reverse polarity protection and overload protection (DC),
surge absorption (DC/AC)
- IP67 (IEC standard)
- Operation confirmed easily by a red indicator lamp
- Wide range of applications (for replacement of micro switch,
limit switch, etc.)



(A)
Counter

(B)
Timer

(C)
Temp.
controller

(D)
Power
controller

(E)
Panel
meter

(F)
Tacho/
Speed/
Pulse
meter

(G)
Display
unit

(H)
Sensor
controller

(I)
Proximity
sensor

(J)
Photo
electric
sensor

(K)
Pressure
sensor

(L)
Rotary
encoder

(M)
5-Phase
stepping
motor &
Driver &
Controller

 Please read "Caution for your safety" in operation manual before using.



■ Specifications

● DC 2-wire type

※ A blacked () item is upgraded function.

Model (※1)	PRCMT12-2DO PRCMT12-2DC PRCMT12-2DO-NP PRCMT12-2DC-NP	PRCMT12-4DO PRCMT12-4DC PRCMT12-4DO-NP PRCMT12-4DC-NP	PRCMT18-5DO PRCMT18-5DC PRCMT18-5DO-NP PRCMT18-5DC-NP	PRCMT18-8DO PRCMT18-8DC PRCMT18-8DO-NP PRCMT18-8DC-NP	PRCMT30-10DO PRCMT30-10DC PRCMT30-10DO-NP PRCMT30-10DC-NP	PRCMT30-15DO PRCMT30-15DC PRCMT30-15DO-NP PRCMT30-15DC-NP
Detecting distance	2mm ±10%	4mm ±10%	5mm ±10%	8mm ±10%	10mm ±10%	15mm ±10%
Hysteresis	Max. 10% of detecting distance					
Standard detecting target	12×12×1mm (Iron)		18×18×1mm (Iron)	25×25×1mm (Iron)	30×30×1mm (Iron)	45×45×1mm (Iron)
Setting distance	0~1.4mm	0~2.8mm	0~3.5mm	0~5.6mm	0~7mm	0~10.5mm
Power supply (Operation voltage)	24VDC (10~30VDC)					
Leakage current	Max. 0.9mA					
Response frequency	800Hz	400Hz	350Hz	200Hz	250Hz	100Hz
Residual voltage (※2)	Max. 4V					
Affection by Temp.	±10% Max. for detecting distance at +20℃ within temperature range of -25 ~ +70℃					
Control output	2~100mA					
Dielectric strength	Min. 50MΩ (at 500VDC)					
Insulation resistance	1500VAC 50/60Hz for 1 minute					
Vibration	1mm amplitude at frequency of 10 ~ 55Hz in each of X, Y, Z directions for 2 hours					
Shock	500m/s ² (50G) in X, Y, Z directions for 3 times					
Indicator	Operation indicator (Red LED)					
Ambient temperature	-25 ~ +70℃ (at non-freezing status)					
Storage temperature	-30 ~ +80℃ (at non-freezing status)					
Ambient humidity	35~95%RH					
Protection circuit	Surge protection circuit, Overload & Short circuit protection					
Protection	IP67 (IEC specification)					
Approval	CE					
Weight	Approx. 26g		Approx. 49g		Approx. 134g	

(※1) The "-I" is for IEC specification, and the "-NP" is for non-polar type.

(※2) For non-polar type, the residual voltage is below 5V.

PRCM Series

■ Specifications

● DC 3-wire type

Model	PRCM12-2DN PRCM12-2DP PRCM12-2DN2 PRCM12-2DP2	PRCM12-4DN PRCM12-4DP PRCM12-4DN2 PRCM12-4DP2	PRCM18-5DN PRCM18-5DP PRCM18-5DN2 PRCM18-5DP2 PRCML18-5DN PRCML18-5DP PRCML18-5DN2 PRCML18-5DP2	PRCM18-8DN PRCM18-8DP PRCM18-8DN2 PRCM18-8DP2 PRCML18-8DN PRCML18-8DP PRCML18-8DN2 PRCML18-8DP2	PRCM30-10DN PRCM30-10DP PRCM30-10DN2 PRCM30-10DP2 PRCML30-10DN PRCML30-10DP PRCML30-10DN2 PRCML30-10DP2	PRCM30-15DN PRCM30-15DP PRCM30-15DN2 PRCM30-15DP2 PRCML30-15DN PRCML30-15DP PRCML30-15DN2 PRCML30-15DP2
Detecting distance	2mm ±10%	4mm ±10%	5mm ±10%	8mm ±10%	10mm ±10%	15mm ±10%
Hysteresis	Max. 10% of detecting distance					
Standard detecting target	12×12×1mm (Iron)		18×18×1mm (Iron)	25×25×1mm (Iron)	30×30×1mm (Iron)	45×45×1mm (Iron)
Setting distance	0~1.4mm	0~2.8mm	0~3.5mm	0~5.6mm	0~7mm	0~10.5mm
Power supply (Operation voltage)	12-24VDC (10-30VDC)					
Current consumption	Max. 10mA					
Response frequency	800Hz	400Hz	350Hz	200Hz	250Hz	100Hz
Residual voltage	Max. 1.5V					
Affection by Temp.	±10% Max. for detecting distance at +20°C within temperature range of -25 ~ +70°C					
Control output	200mA					
Insulation resistance	Min. 50MΩ (at 500VDC)					
Dielectric strength	1500VAC 50/60Hz for 1 minute					
Vibration	1mm amplitude at frequency of 10 ~ 55Hz in each of X, Y, Z directions for 2 hours					
Shock	500m/s ² (50G) in X, Y, Z directions for 3 times					
Indicator	Operation indicator (Red LED)					
Ambient temperature	-25 ~ +70°C (at non-freezing status)					
Storage temperature	-30 ~ +80°C (at non-freezing status)					
Ambient humidity	35~95%RH					
Protection circuit	Reverse polarity protection, Surge protection circuit, Overload & short circuit protection					
Protection	IP67 (IEC specification)					
Approval	CE					
Weight	Approx. 26g		PRCM18 : Approx. 49g PRCML18 : Approx. 73g		PRCM30 : Approx. 134g PRCML : Approx. 169g	

● AC 2-wire type

Model	PRCM12-2AO PRCM12-2AC	PRCM12-4AO PRCM12-4AC	PRCM18-5AO PRCM18-5AC PRCML18-5AO PRCML18-5AC	PRCM18-8AO PRCM18-8AC PRCML18-8AO PRCML18-8AC	PRCM30-10AO PRCM30-10AC PRCML30-10AO PRCML30-10AC	PRCM30-15AO PRCM30-15AC PRCML30-15AO PRCML30-15AC
Detecting distance	2mm ±10%	4mm ±10%	5mm ±10%	8mm ±10%	10mm ±10%	15mm ±10%
Hysteresis	Max. 10% of detecting distance					
Standard detecting target	12×12×1mm (Iron)		18×18×1mm (Iron)	25×25×1mm (Iron)	30×30×1mm (Iron)	45×45×1mm (Iron)
Setting distance	0~1.4mm	0~2.8mm	0~3.5mm	0~5.6mm	0~7mm	0~10.5mm
Power supply (Operating voltage)	100-240VAC (85-264VAC)					
Current consumption	Max. 2.5mA					
Response frequency	20Hz					
Residual voltage	Max. 10V					
Affection by Temp.	±10% Max. for detecting distance at +20°C within temperature range of -25 ~ +70°C					
Control output	5~150mA			5~200mA		
Insulation resistance	Min. 50MΩ (at 500VDC)					
Dielectric strength	2500VAC 50/60Hz for 1 minute					
Vibration	1mm amplitude at frequency of 10 ~ 55Hz in each of X, Y, Z directions for 2 hours					
Shock	500m/s ² (50G) in X, Y, Z directions for 3 times					
Indicator	Operation indicator (Red LED)					
Ambient temperature	-25 ~ +70°C (at non-freezing status)					
Storage temperature	-30 ~ +80°C (at non-freezing status)					
Ambient humidity	35~95%RH					
Protection circuit	Surge protection circuit built-in					
Protection	IP67 (IEC specification)					
Approval	CE CCC					
Weight	Approx. 30g		PRCM18 : Approx. 53g PRCML18 : Approx. 74g		PRCM30 : Approx. 134g PRCML : Approx. 169g	

Quick Disconnection Type

■ Dimensions

Unit:mm

●PRCM(T)12-2D□

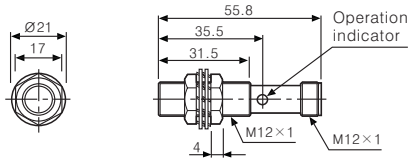

●PRCM(T)12-4D□

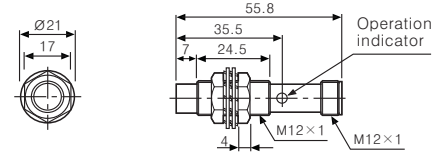

●PRCM(T)18-5D□

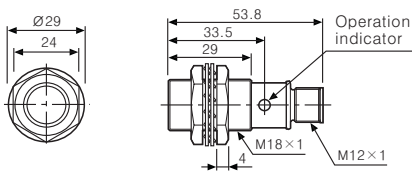

●PRCM(T)18-8D□

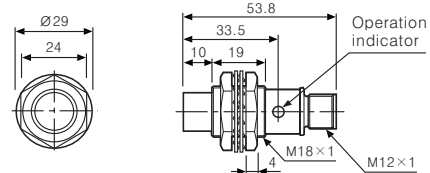

●PRCM(T)30-10D□

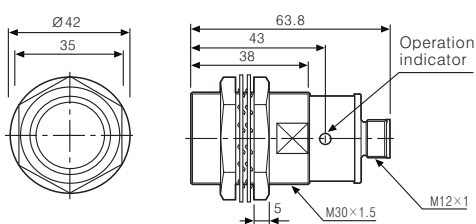

●PRCM(T)30-15D□

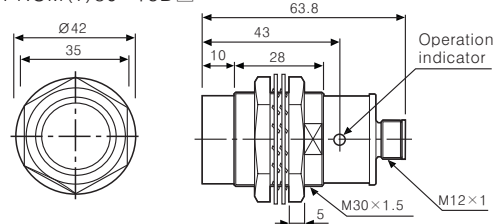

●PRCM12-2A□

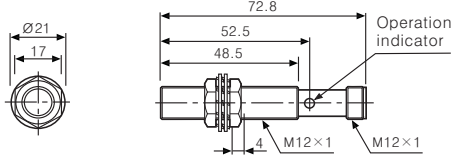

●PRCM12-4A□

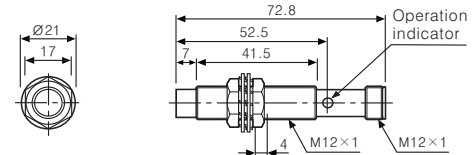

●PRCM18-5A□

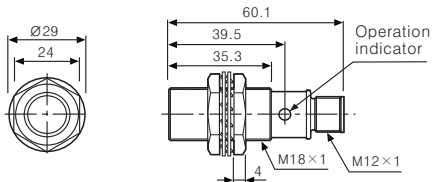

●PRCM18-8A□

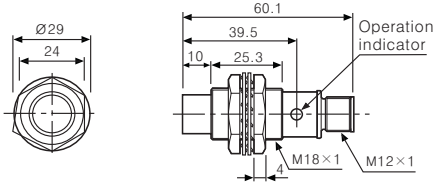

●PRCM30-10A□

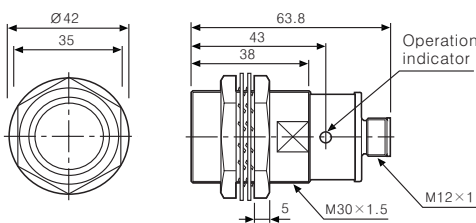

●PRCM30-15A□

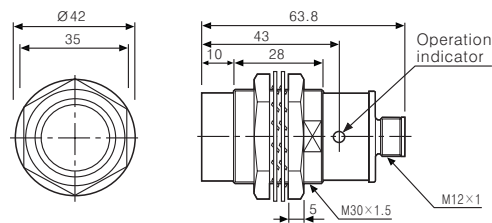

●PRCML18-5D□ / PRCML18-5A□

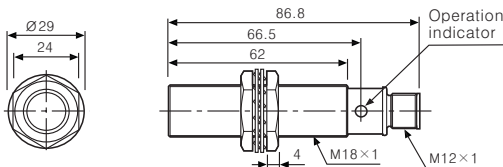

●PRCML18-8D□ / PRCML18-8A□

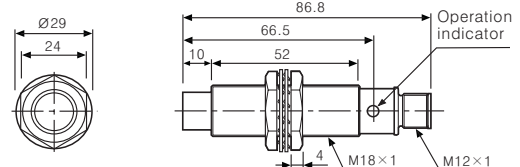

●PRCML30-10D□ / PRCML30-10A□

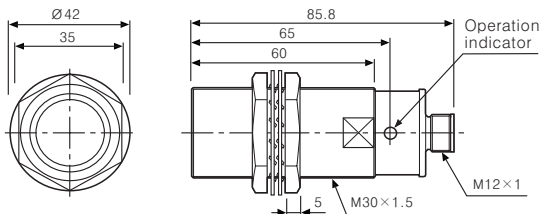

●PRCML30-15D□ / PRCML30-15A□

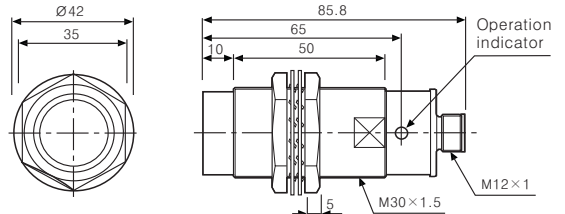

(A)
Counter

(B)
Timer

(C)
Temp.
controller

(D)
Power
controller

(E)
Panel
meter

(F)
Tacho/
Speed/
Pulse
meter

(G)
Display
unit

(H)
Sensor
controller

(I)
Proximity
sensor

(J)
Photo
electric
sensor

(K)
Pressure
sensor

(L)
Rotary
encoder

(M)
5-Phase
stepping
motor &
Driver &
Controller

PRCM Series

Control output diagram

DC 2-wire type

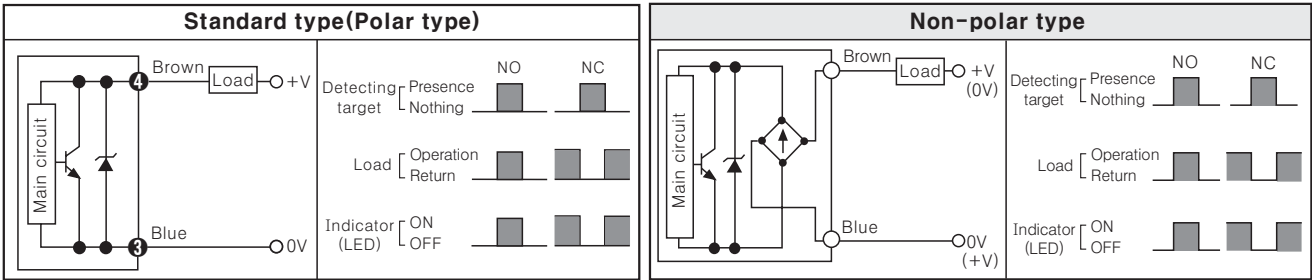

※ It is connectable without affecting polarity.

DC 3-wire type

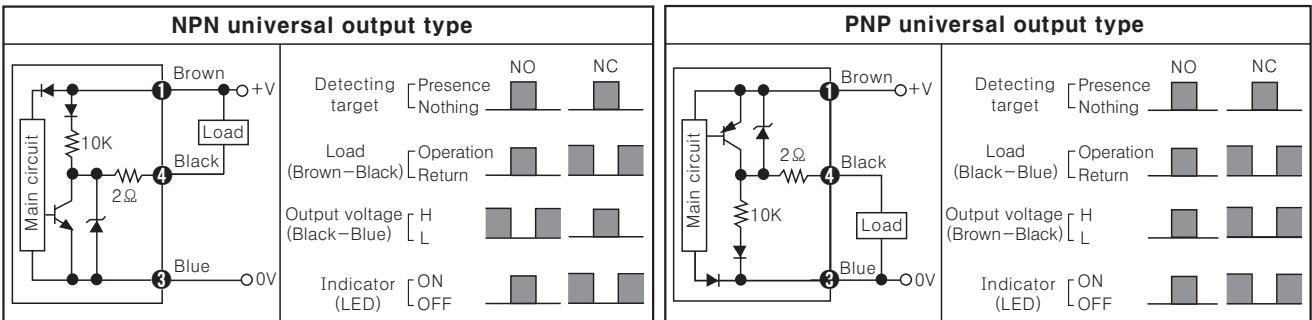

AC 2-wire type

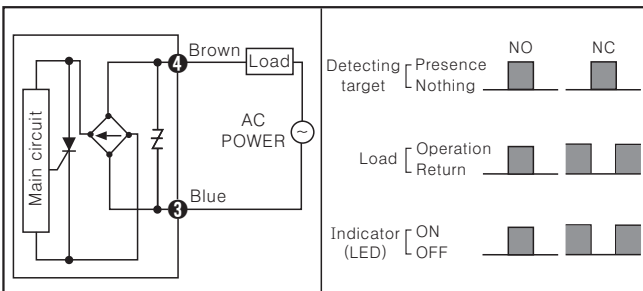

※ Number in circle are pin number.

Wiring diagram

DC 2-wire type(Standard/non-polar type)

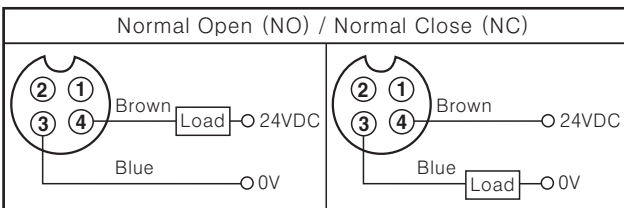

※ Pin ① and ② are not connected.
 ※ Non-polar type has the same connections.
 ※ When using DC 3-wire type of connector cable, black(24VDC) and blue(0V) cables can be used.

DC 2-wire type(IEC standard/IEC standard non-polar type)

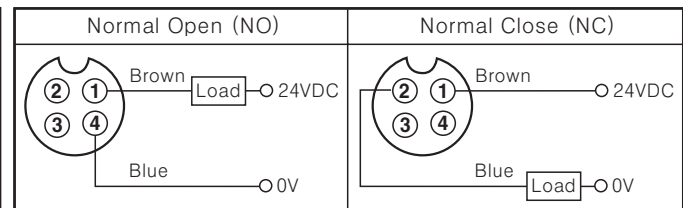

※ Non-polar type by IEC standard has the same connections.
 ※ Please put " I " behind of model name for selecting proximity sensor by IEC standard.
 Ex) CID2-2-I, CLD2-2-I

DC 3-wire type

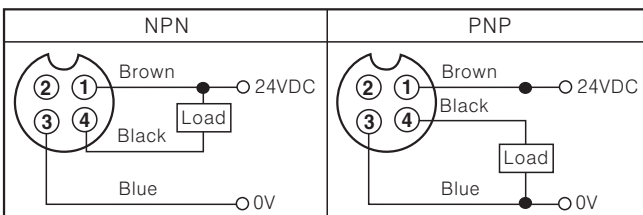

AC 2-wire type

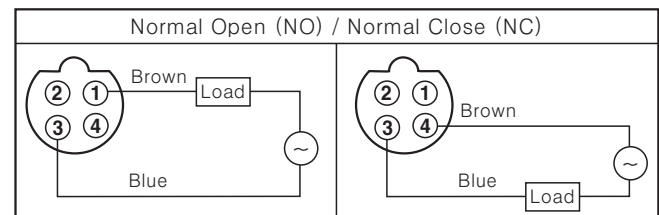

※ In case of AC switching type, ② and ③, ① and ④ are connected to each other inside.

Quick Disconnection Type

■ Proper usage

○ Load connections

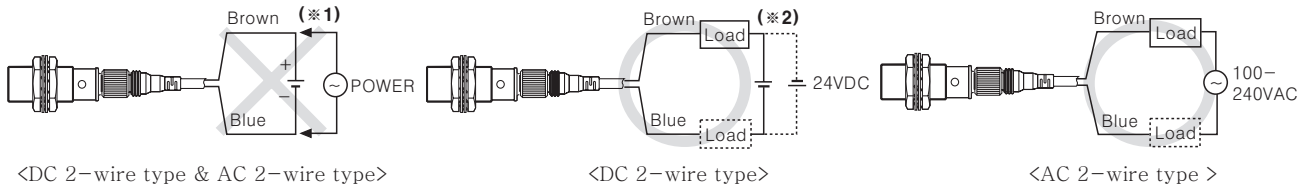

<DC 2-wire type & AC 2-wire type>

<DC 2-wire type>

<AC 2-wire type >

※1. When using DC 2-wire and AC 2-wire type, a load must be connected before applying power; otherwise, components can be damaged. The load is connectable without affecting polarity.

※2. For non-polar type of DC-2 wire type, it is connectable without affecting polarity.

○ In case of the load current is small

● AC 2-wire type

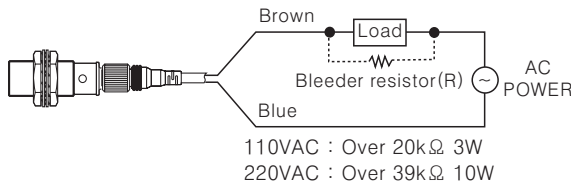

It may cause return failure of load by residual voltage.

If the load current is under 5mA, please make sure the residual voltage is less than the return voltage of the load by connecting a bleeder resistor in parallel with the load as shown in the diagram.

● DC 2-wire type

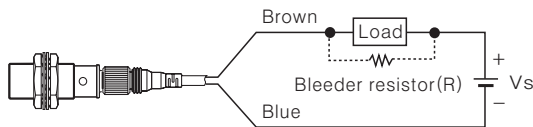

Please make the current on proximity sensor smaller than the return current of load by connecting a bleeder resistor in parallel.

※W value of bleeder resistor should be bigger for proper heat dissipation.

$$R \leq \frac{V_s}{I_o - I_{off}} \text{ (k}\Omega\text{)} \quad P > \frac{V_s^2}{R} \text{ (mW)}$$

* V_s : Power supply P : Bleeder resistor, number of W
 I_o : Operating current 2mA of proximity sensor
 I_{off} : Return current of load

○ Mutual-interference & Influence by surrounding metals

When several proximity sensors are mounted close together, malfunction of sensor may be caused due to mutual interference. Therefore, be sure to provide a minimum distance between the two sensors, as below charts.

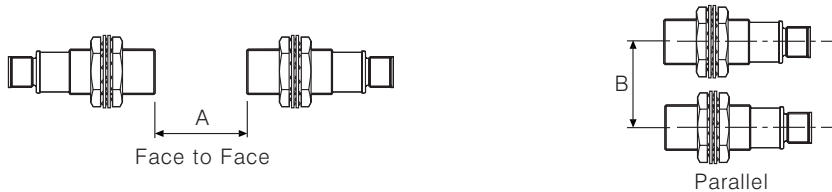

When sensors are mounted on metallic panel, it must be prevented sensors from being affected by any metallic object except target. Therefore, be sure to provide a minimum distance as below chart.

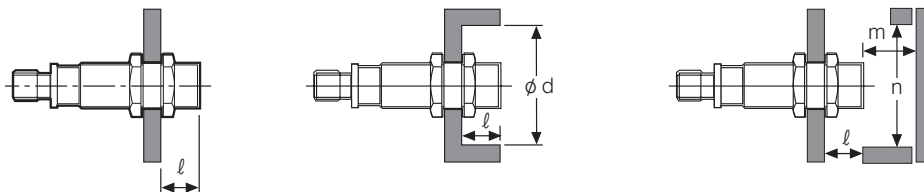

Unit:mm

Model	PRCMT12-2D□ PRCM12-2D□ PRCM12-2A□	PRCMT12-4D□ PRCM12-4D□ PRCM12-4A□	PRCMT18-5D PRCM(L)18-5D PRCM(L)18-5A	PRCMT18-8D□ PRCM(L)18-8D□ PRCM(L)18-8A□	PRCMT30-10D□ PRCM(L)30-10D□ PRCM(L)30-10A□	PRCMT30-15D PRCM(L)30-15D PRCM(L)30-15A
A	12	24	30	48	60	90
B	24	36	36	54	60	90
l	0	11	0	14	0	15
∅d	12	36	18	54	30	90
m	6	12	15	24	30	54
n	18	36	27	54	45	90

(A)
Counter

(B)
Timer

(C)
Temp.
controller

(D)
Power
controller

(E)
Panel
meter

(F)
Tacho/
Speed/
Pulse
meter

(G)
Display
unit

(H)
Sensor
controller

(I)
Proximity
sensor

(J)
Photo
electric
sensor

(K)
Pressure
sensor

(L)
Rotary
encoder

(M)
5-Phase
stepping
motor &
Driver &
Controller